

Introduction

A mobile robot can't be considered autonomous without being able to perform the simultaneous localization and mapping (SLAM) methodology, where it simultaneously creates a map of its unknown environment and localize itself on that map, see Fig. 2. A **classical** SLAM navigation system relies mainly on *algorithms* for data association, visual data processing (e.g., recognition and comparison), path integration (PI) error rectification, etc. Whereas, a **neurobiological** based system relies heavily on intricately *integrated neural networks* to accomplish these same tasks.

Abstract

In theory, an autonomous mobile robot's ability to navigate with greater intelligence and flexibility in a dynamic environment would be possible if its navigation system was modeled after that of biological creatures. More specifically, to create an agent that mimics neurobiological navigation cells and neural network connections as found in the **hippocampus** and **entorhinal cortex** of rodent brains (Fig. 1). These navigation cells are the: **place cells**, **head direction cells**, **boundary cells**, and **grid cells**, as well as **memory**. To navigate from one waypoint to another, our mobile robot, known as **ratbot**, uses inspiration from place cells and head direction cells for **path integration**. This is accomplished through use of vectors and vector mathematics. Additionally, the **ratbot** uses a field programmable gate array (**FPGA**) to emulate grid cell functionality for environment mapping and spatial cognition.

Path Integration

Path integration (PI) was first suggested by Darwin [1], and confirmation this hypothesis, was shown in [2]. Fig. 3 illustrates the concept of PI used by animals, as well as the **ratbot**. In this figure, the rat leaves his or her home, travels around the enclosed area until it finds food, then returns home. The foraging/navigation task is accomplished by the rat continuously updating a return vector home approximation from the change in its **head direction** via **vestibular stimuli**, and **distance traveled** via **proprioceptive stimuli**. Similarly, the **ratbot's** "brain", an Arduino microcontroller board, uses distance traveled information gathered from the **ratbot's** motor encoders and the measured change in direction from a microelectromechanical systems (MEMS) based **gyroscope**, for calculating the return distance and direction to home, respectively, see Fig. 4 and Fig. 5a for physical implementation. The **ratbot's** vision (**ultrasonic sensor**) is for object avoidance only. This is similar to a rat foraging in the dark.

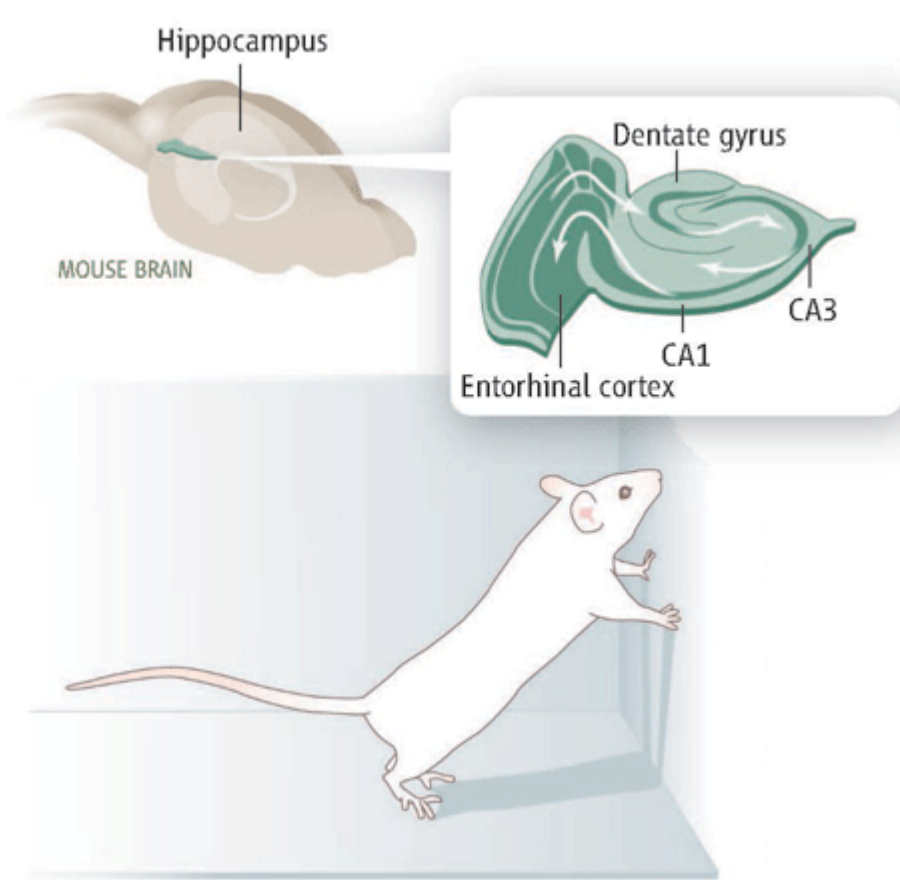

Figure 1: Rodent's hippocampus and entorhinal cortex [4].

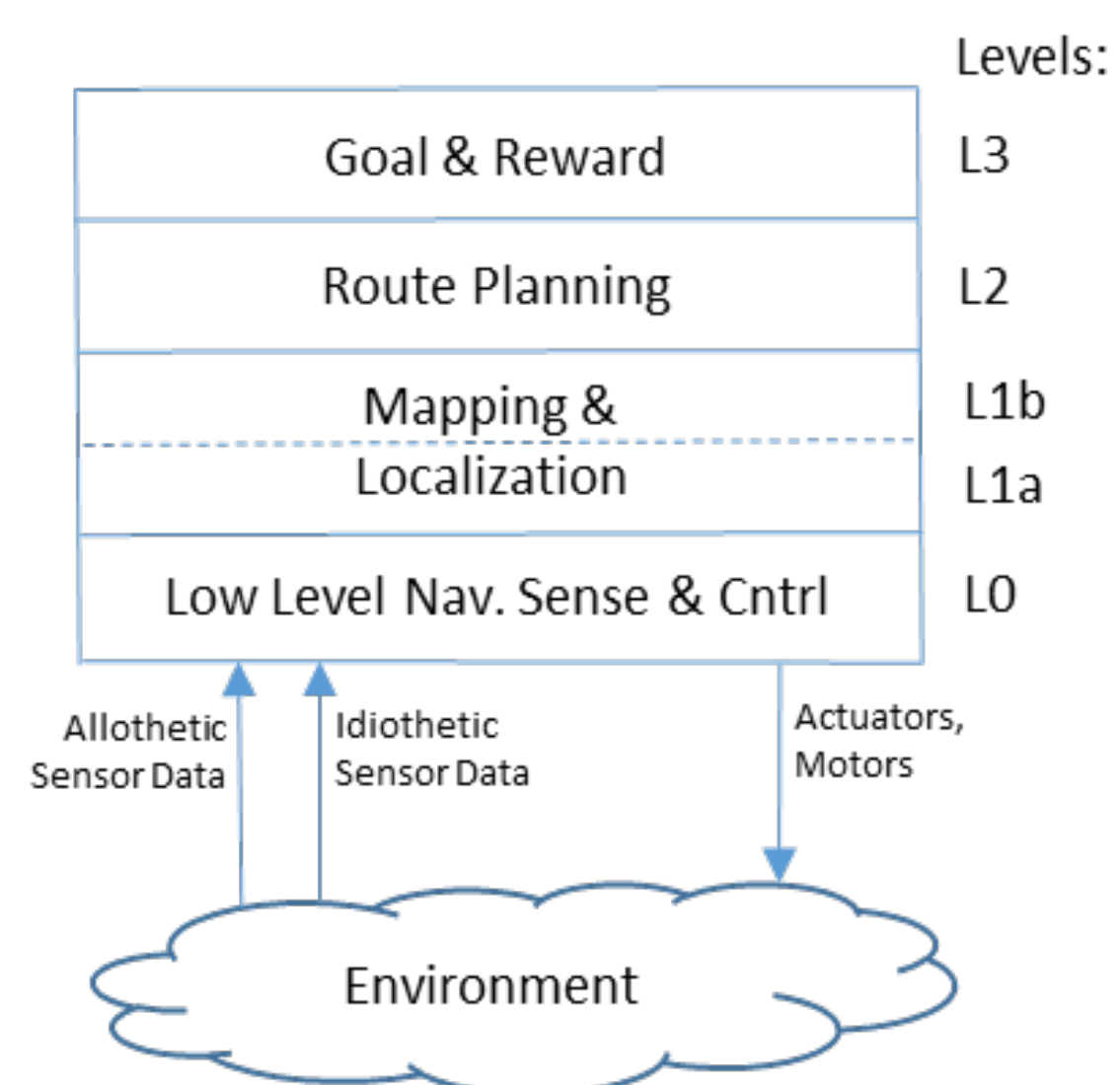

Figure 2: General layers of navigation. **SLAM** occurs at L1 (a&b) and is dependent on the accuracy of **PI** in L0.

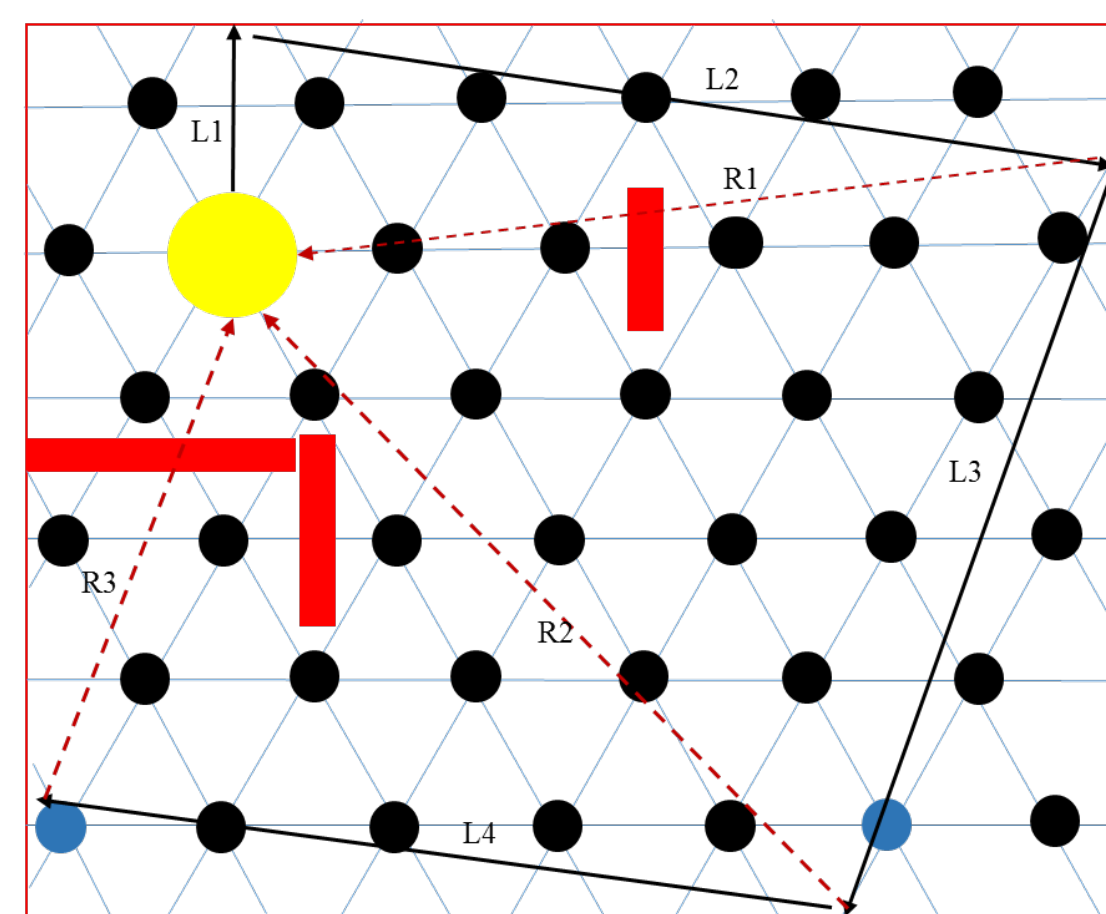

Figure 3: An example environment and travel scenario of the ratbot. For **PI**: The yellow dot is the ratbot's home (start and ending position). The black arrows (L_n) represents a travel leg of the journey. The red dashed arrows (R_n) are the return vectors calculated along the way (**PI**).

Analysis: PI Error

Due to sensor measurement errors, robot drift, and/or other possible external influences, the robot's true end location and heading are typically at odds with its true pose. This **PI error** accumulates with time as the robot continues to roam (Fig. 7). The **ratbot** experiences a slow enough accumulating **PI error** such that adding a simple allothetic sensor (e.g., pattern recognition camera) and dispersed salient distal cues, will bound this error.

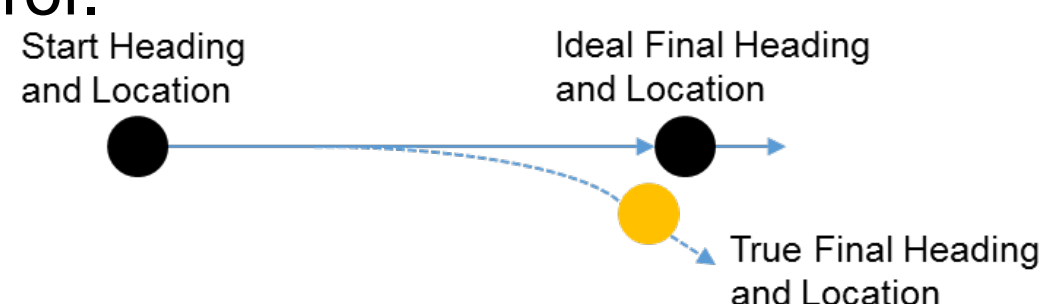

Figure 7: Accumulating **PI error** in a mobile robot and as seen with the **ratbot**.

Spatial Cognition

Through the use of an **FPGA** (Fig. 5b), the **ratbot's** environment (Fig. 3) is **logically** mapped into a two dimensional array of parallel processing units. **Each unit is an instantiated grid cell's firing location/region**, see Fig. 6 a&b and block dots of Fig. 3. In a rodent or any mammal, a single grid cell fires whenever the animal has crossed (or stopped on) a spot that the animal has visited before. **The hexagonal lattice firing locations of a single grid cell covers the entire local environment that the rat is currently exploring.**

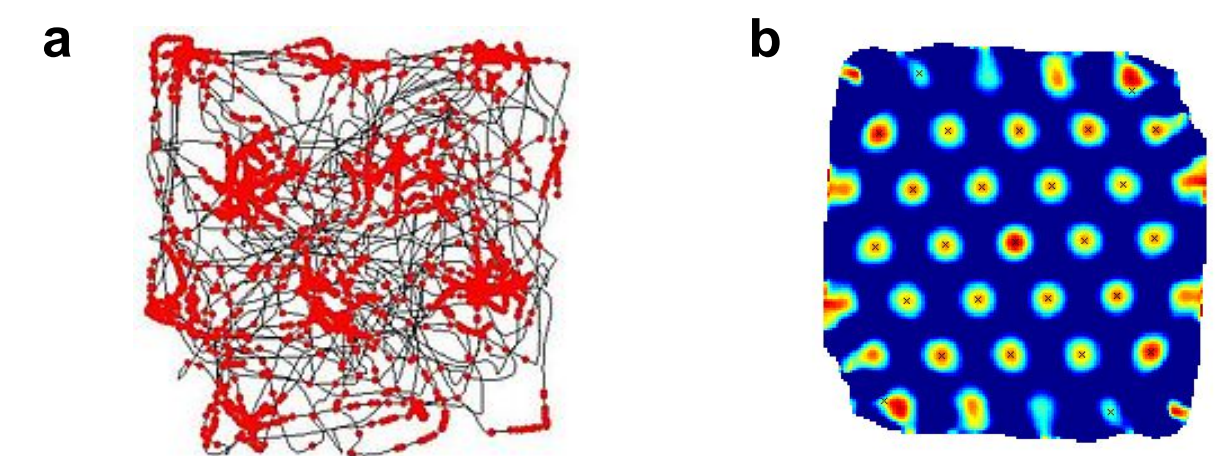

Figure 6: a) Recorded firing locations (red dots) of a **single grid cell**, as a rat explores (black line) a square, enclosed area. Such recordings are obtained by installing an electrode in a rat's cerebral cortex, where it picks up the firing of a single grid cell as the rat moves around his enclosure. **b)** The autocorrelogram of the firing data for the grid cell. The hexagonal pattern of the firing locations can be seen in both parts **a** and **b** of the figure [3].

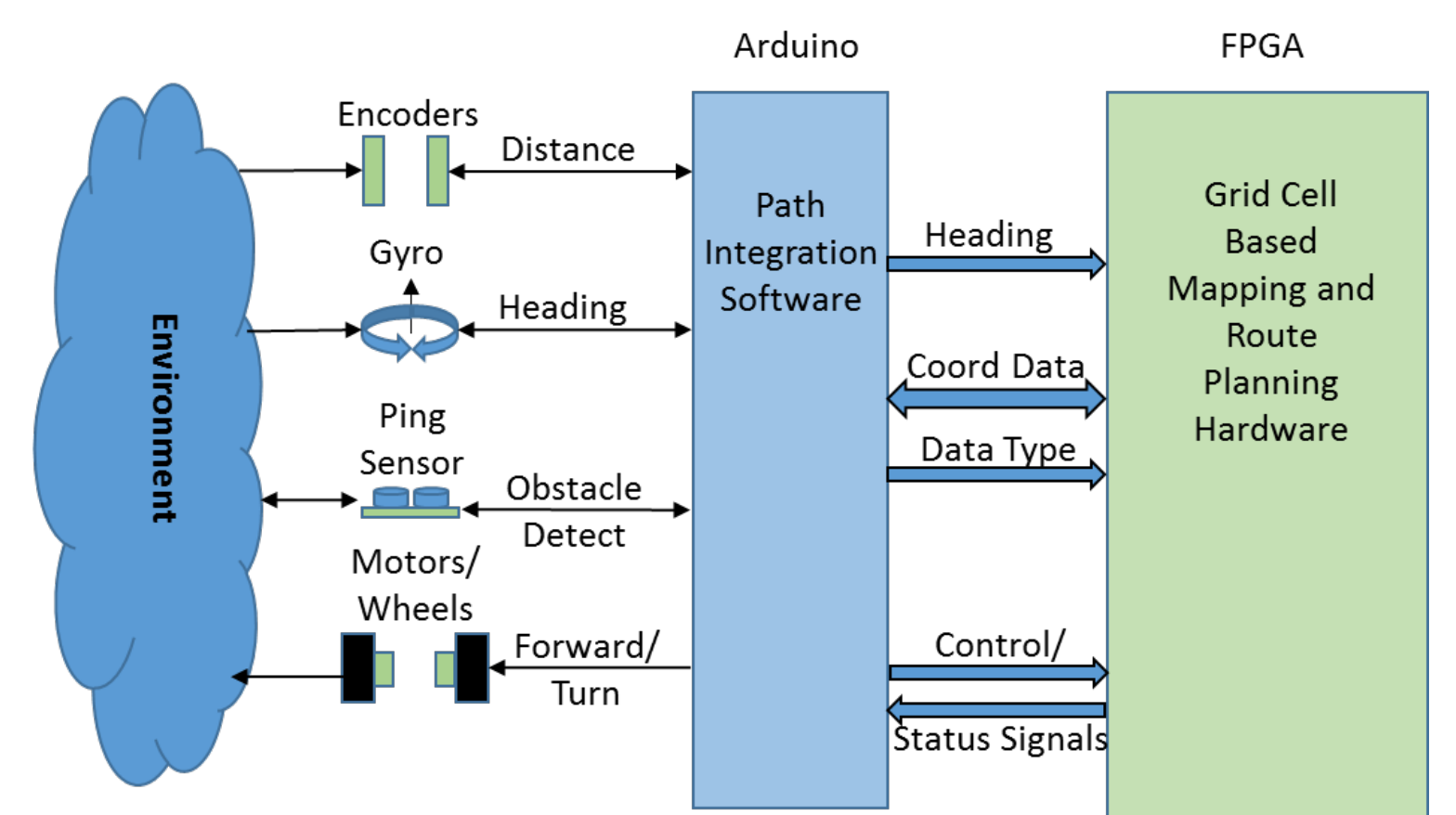

Figure 4: A top level block diagram of the path integration, mapping and route planning circuitry as implemented in the **ratbot** to simulate the specialized neurobiological navigation cells found in a rat's brain.

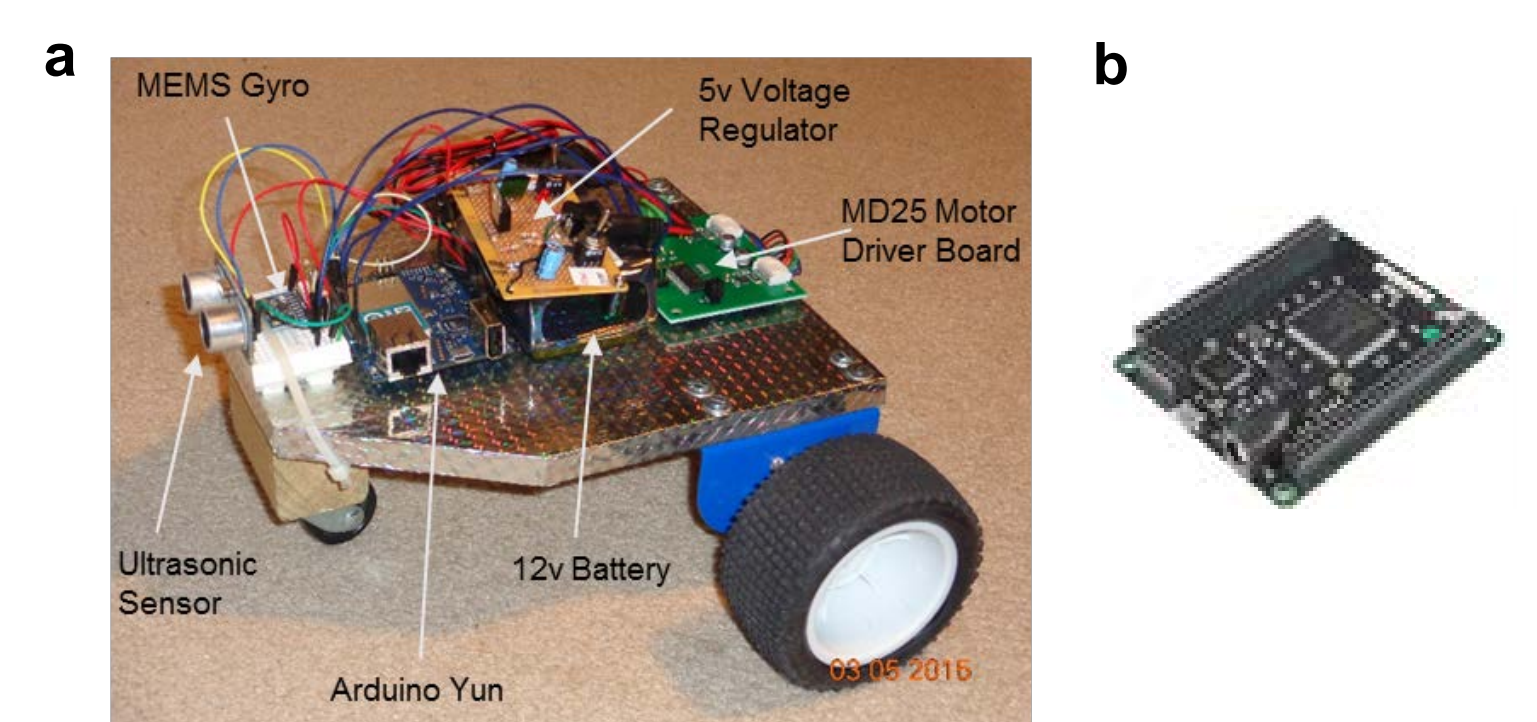

Figure 5: a) The **ratbot** and b) the Mojo Xilinx FPGA board.

References

- [1] C. Darwin, "Origin of Certain Instincts," *Nature*, vol. 7, pp. 417-418, 1873.
- [2] H. Mittelstaedt and M.-L. Mittelstaedt, "Homing by path integration," in *Avian navigation*, ed: Springer, 1982, pp. 290-297.
- [3] http://en.wikipedia.org/wiki/Grid_cell
- [4] <http://mindblog.dericbownds.net>